

FUSION[®]



FN-6016 INSTRUCTION MANUAL



Fenix Product Copyrights This price List and the mentioned Fenix products include or describe copyrighted Fenix material. Laws in the United States and other countries preserve for Fenix Industries and its licensors certain exclusive rights for copyrighted material, including the exclusive right to copy, reproduce in any form, distribute and make derivative works of the copyrighted material. Accordingly, any copyrighted material of Fenix and its licensors contained herein or in the Fenix products described in this Price List may not be copied, reproduced, distributed, merged or modified, transmitted, transcribed, stored in retrieval system or translated into any language or computer language, in any form or by any means, without prior written permission of Fenix Industries, Inc.. Fenix and the stylized Fenix logo are registered in the U.S. Patent & Trademark Office.



TABLE OF CONTENTS



Safety Regulations & Warranty	3
Service after Expiration	3
Copyright	3
Feniex Product Copyright	3
Specifications, Flash Patterns, & Wiring	4
Specifications	4
Flash Patterns	4
Cruise Flash Patterns	4
Flood Mode Options	4
Box Contents	4
Mount Kits	4
Equipment Dimensions	4
Wiring Diagrams	5
Power Connection	5
Standard Configuration	5
Stop/Tail/Turn & Work Lights	5
Wiring Information & Functions	6
Power Cable Wiring	6
Warning Mode Activation	6
Flash Pattern Selection	6
Flood Mode Activation	6
Flood Mode Selection	6
Takedown Activation	6
Alley Light Activation	6
Cruise Mode Activation	6
Cruise Pattern Selection	6
Dim Mode Activation	6
Arrow Function Activation	6
Work Light Activation	7
Stop / Tail / Turn Lights	7
Mounting Straps & Brackets	8
Vehicle Specific Hook Mounts	8
Universal Mounts	8

SAFETY REGULATIONS & WARRANTY



SAFETY REGULATIONS

The following provides all the information necessary to safely operate the previously listed products of Feniex Industries, Inc. Please read this manual thoroughly before installing or operating your new product in order to prevent any damage or injury. Failure to follow the listed instructions in this manual may result in damage to your products or personal injury.

- Proper installation of this product requires good knowledge of automotive systems, electronics & procedures.
- Please guarantee all vital components of the vehicle are not in danger of being damaged by drilling holes necessary for installation. Check all sides of the mounting surface before drilling any holes into the vehicle.
- Do not install this product in any way that interferes with the deployment of the air bag. Doing so may damage the effectiveness of the air bag & can lead to serious personal and vehicle injury. The installer will assume full responsibility of proper installation of the new unit.
- Please clean the mounting surface before installation of the unit when using tape, brackets, magnet, Velcro or suction cups.
- The product's ground wire must be connected directly to the negative (-) battery post for effective use of the unit. Please follow all wiring guidelines provided to guarantee long lifespan & productivity. Failing to follow these instructions may result in damage to the product.

WARRANTY

Feniex Industries, Inc. warrants to the original purchaser that the product shall be free from defects in material & workmanship for 5 years from the date of purchase for all LED products. Feniex Industries warranties speakers, sirens, flashers, & controllers for 2 years.

If warranty service is needed, please contact customer support:

Phone: 1.800.615.8350

Web Site: www.Feniex.com/support

Email: techsupport@feniex.com

If the product needs to be returned for repair or replacement, contact our customer service team (using any method listed above) to receive a Return Merchandise Authorization (RMA) number. Operational times are from 9 a.m. to 6 p.m. central time, Monday through Friday.

 Please do not send in product without contacting support first for a Return Merchandise Authorization (RMA) number.

CONDITIONS

Feniex Industries, Inc. will not be held responsible for any costs associated with equipment removal and/or re-installation resulting from a warranty claim. It is the sole responsibility of the party initiating a warranty claim to pay shipping charges associated with returning a product to Feniex Industries for repair or replacement.

SERVICE AFTER EXPIRATION

Feniex Industries will still provide service for all products after expiration of the warranty. For any issues, call the customer support line. In some instances it may be necessary for the product to be shipped, freight prepaid and insured for loss or damage to Feniex headquarters.



Utilizing non-factory screws and mounting brackets may result in the loss of warranty coverage.

COPYRIGHT

This instruction manual and the Feniex products described in this instruction manual may include or describe copyrighted Feniex material. Laws in the United States and other countries preserve for Feniex Industries and its licensors certain exclusive rights for copyrighted material, including the exclusive right to copy, reproduce in any form, distribute and make derivative works of the copyrighted material. Accordingly, any copyrighted material of Feniex and its licensors contained herein or in the Feniex products described in this instruction manual may not be copied, reproduced, distributed, merged or modified in any manner without the express written permission of Feniex Industries, Inc.

FENIEX PRODUCT COPYRIGHTS

The products described in this document are the property of Feniex Industries, Inc. It is furnished by express license agreement only and may be used only in accordance with the terms of such an agreement. Products and documentation are copyrighted materials. Making unauthorized copies is prohibited by law. No part of the product or documentation may be reproduced, transmitted, transcribed, stored in retrieval system or translated into any language or computer language, in any form or by any means, without prior permission from Feniex Industries, Inc.

SPECIFICATIONS, PATTERNS, & WIRING



SYSTEM SPECIFICATIONS

Input Power	12 - 24 VDC
Current Draw	15 Amps
External Fuse	125% of Circuit Load
Cable	15 Feet
Colors	Amber, Red, Blue, White, Green
SAE Certification	Class 1, J595, CT13, J1113-11
Flash Patterns	18 Single Color, 52 Dual Color
LED Technology	Cree, 4 Watt
Dimensions	59.5" L x 1.6" H x 11.8" W
Warranty	5 Years

FLASH PATTERNS

1) Cluster Pattern	Single & Dual Color Modes
2) Attack Pattern	Single & Dual Color Modes
3) Night Ride Pattern	Single & Dual Color Modes
4) Half-Half [Slow]	Single & Dual Color Modes
5) Half-Half [Fast]	Single & Dual Color Modes
6) One-One [Slow]	Single & Dual Color Modes
7) One-One [Fast]	Single & Dual Color Modes
8) Two-Two [Slow]	Single & Dual Color Modes
9) Two -Two [Fast]	Single & Dual Color Modes
10) All-On [Slow]	Single & Dual Color Modes
11) All-On [Fast]	Single & Dual Color Modes
12) In-Out [Slow]	Single & Dual Color Modes
13) In-Out [Fast]	Single & Dual Color Modes
14) Combo: All Slow	Single & Dual Color Modes
15) Combo: All Fast	Single & Dual Color Modes
16) Combo: Fast & Slow	Single & Dual Color Modes
17) Quad Flash: Half-Half	Single & Dual Color Modes
18) Quad Flash: In-Out	Single & Dual Color Modes

CRUISE FLASH PATTERNS

1) All On
2) Single Flash [Slow], Simultaneous
3) Single Flash [Flash], Simultaneous
4) Single Flash [Slow], Alternating
5) Single Flash [Flash], Alternating
6) Single Flash [Slow], Corners, Alternating
7) Single Flash [Fast], Corners, Alternating
8) Attack Pattern

FLOOD MODE OPTIONS

- 1) Front Modules
- 2) Front & Side Modules (excluding alley)
- 3) Front, Side (excluding alley), & Rear/Arrow Modules
- 4) Side & Rear/Arrow Modules
- 5) Rear/Arrow Modules

BOX CONTENTS



BOX CONTENTS	QUANTITY
1. Fusion 60" GPL	1
2. Standard Foot Mount	2*

*Permanent or Headache Rack Mounts may be substituted at time of purchase

MOUNT KITS*	PART NUMBER
Standard Foot Mount	FN-9716-M-F*
Permanent Mount	FN-9916-M-P*
Headache Rack Mount	FN-9816-M-H*
Adjustable Foot Mount	FN-9927-AF*

*Sold Separately, in pairs

See page 8 for a full list of available vehicle specific light bar strap kits.

DIMENSIONS

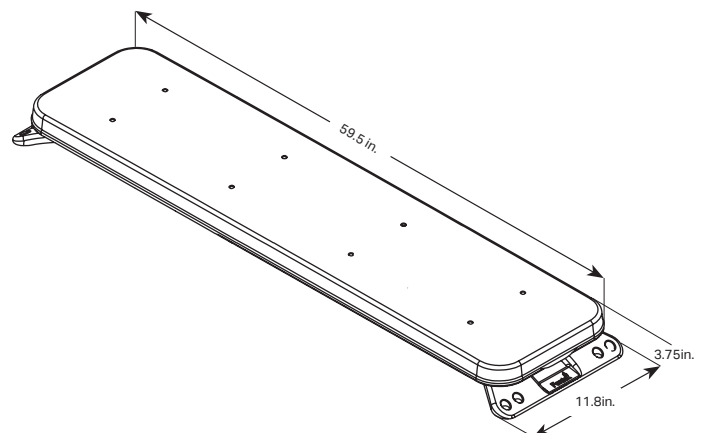

WIRING DIAGRAMS



WIRING DIAGRAM: POWER CONNECTIONS

Wire Color	Function	Polarity	Description
Black	Ground	12v (-)	Connect to vehicle's negative battery post
Red	Positive	12v (+)	Connect to vehicle's positive battery post

! All user-supplied wires connecting to 12v (+) or 12v (-) must be sized to supply 100% of the maximum current and properly fused at the power source with a fuse rated at 125% of the total circuit load. Avoid routing wires in the deployment area of the vehicle air bag or any other potentially hazardous locations.

WIRING DIAGRAM: STANDARD CONFIGURATION

Wire Color	Function	Polarity	Description
Green/White	Mode 0 Rear	12v (+)	Activates rear-facing modules, corners, & sides
Blue/White	Mode 0 Front	12v (+)	Activates front-facing modules & corners
Black	Mode 1	12v (+)	Warning Mode 1 [Overrides Mode 0]
Red	Mode 2	12v (+)	Warning Mode 2 [Overrides Mode 0 & 1]
Orange	Mode 3	12v (+)	Warning Mode 3 [Overrides Modes 0, 1 & 2]
Green	Cruise Mode	12v (+)	Corner Modules [10% Brightness]
Blue	Takedown	12v (+)	Overrides Modes 1, 2, & 3 Flash Patterns
Red/Black	Left Alley	12v (+)	Steady Burn [Overrides Flashing]
White	Right Alley	12v (+)	Steady Burn [Overrides Flashing]
Orange/Black	Flashing TD/Alley	12v (+)	Flashes Takedown & Alley Lights
Green/Black	Flood Mode	12v (+)	Activates Flood Mode [if dual color, if configured]
Blue/Black	Dim	12v (+)	Dims Lightbar [Takedown, Alley, & Flood Unaffected]
White/Black	Arrow Left	12v (+)	Left Arrow [Overrides Flashing]
Black/White	Arrow Right	12v (+)	Right Arrow [Overrides Flashing]
Wht/Blk + Blk/Wht	Center Out	12v (+)	Center-Out Arrow [Overrides Flashing]
Red/White	Pattern Changer	12v (+)	Momentary, cycles through flash patterns

! When Mode 1 Front or Mode 1 Rear is active, the side positions will not activate. If both Mode 1 Front and Rear are active or Modes 3 or 4 are active, the side positions will activate (if not configured as alley positions).

WIRING DIAGRAM: STOP/TAIL/TURN & WORK LIGHTS

Wire Color	Function	Polarity	Description
Orange	Tail Lights	12v (+)	Steady Burn of both tail lights [10% Brightness]
Red	Work Lights	12v (+)	Steady Burn
Green	Left Brake/Turn	12v (+)	[Overrides Tail Light]
Blue/Black	Right Brake/Turn	12v (+)	[Overrides Tail Light]

*All other activation wires retain original function

WIRING INFORMATION & FUNCTIONS



POWER CABLE WIRING











- 1) Install a customer-supplied fuse rated for 125% of the circuit load to the end of the red wire. Do not use a circuit breaker or fusible link.
- 2) Connect the opposite end of the fuse to the 12v+ terminal of the battery. Do not use more than 1 foot of wire between the fuse and the battery terminal to ensure appropriate protection.
- 3) Connect the black wire to the vehicle chassis ground.
- 4) Connect the function wires to switches, depending on the functions needed for applications (See page 6 for wiring diagrams).

WARNING MODES

Activate the warning modes by extending the blue/white (front) and green/white (rear) wires to 12v (+) latching switches to activate mode 1 (front and/or rear as desired). When power is supplied to mode 2 (black), the pattern will be changed for the active display. When power is supplied to Mode 3 (red) or mode 4 (orange) wires, the selected pattern for each mode will display on the whole bar (front and rear).

 If Mode 1 front and/or Mode 1 rear isn't active, Mode 2 will not function. Mode 2 only overrides an active Mode 1 function.

Example:

-  = Mode 1, Rear
-  +  = Mode 2 Pattern, Rear Only
-  +  = Mode 1, Front & Rear
-  +  = Mode 2 Pattern, Front Only
-  +  +  = Mode 2 Pattern, Front & Rear

Effectively, 4 patterns can be displayed in any variation of single and/or dual colors (if configured as a dual color lightbar). Patterns for front and rear (Modes 1 & 2) will always match, patterns cannot be split (front to rear) in any mode.

FLASH PATTERNS

Advance the pattern by extending the red/white wire to a 12v (+) momentary switch or tap the red/white wire to a 12v (+) terminal for 1 second.

 Mode 1 activates front & rear independently, Mode 2 overrides the current pattern of the active Mode 1 display, Mode 3 & 4 activate both front and rear, with Mode 4 overriding all modes.

 A different pattern can be set for each of the four modes. The pattern will only be changed for the active pattern.

FLOOD MODE

Activate flood mode by extending the green/black wire to a 12v (+) latching switch.

FLOOD MODE SELECTION

Activate flood mode and use the red/white pattern change wire to select the desired flood mode.

TAKEDOWN

Activate the factory configured takedown function by extending the white wire to a 12v (+) latching switch.

ALLEY LIGHTS

Activate the factory configured alley lights by extending the red/black & white wires to 12v (+) latching switches.

 Takedown & alley functionality must be specified at time of order. Modules in takedown and/or alley positions will only function as such, or flashing takedown/alley. No warning patterns will be displayed in takedown or alley positions.

TAKEDOWN & ALLEY FLASHING

Activate the factory configured takedown flashing function by extending the green wire to a 12v (+) latching switch. For dual color models, warning mode 2 will be activated instead of the flashing takedown function.

CRUISE MODE

Activate Cruise Mode by extending the green wire to a 12v (+) latching switch.

CRUISE PATTERN SELECTION

- 1) Apply 12v (+) to the cruise mode wire (green).
- 2) Apply 12v (+) (momentary) to the red/white wire to advance the pattern of the cruise mode.

DIM MODE

Activate Dim Mode by extending the blue/black wire to a 12v (+) latching switch.

 Dim Mode is only available on hard-wire models. This mode will dim all modes except for Takedown functions & Flood Mode.

ARROW FUNCTIONS

Activate the arrow functions by extending the white/black wire, black/white wire, or a combination of both to 12v (+) latching switches.

 Arrow functions will override all warning modes on all rear-facing modules (not including corners).

WIRING INFORMATION & FUNCTIONS

 Work Light and Stop/Tail/Turn functionality must be specified at time of order. Modules in work light and/or STT positions will only function as such. No warning patterns will be displayed in work light or STT positions.

WORK LIGHTS

If equipped, activate the factory configured work lights by extending the red wire (Mode 3) to a 12v (+) latching switch.

 If work light functionality is specified at time of order, it will replace Mode 3 functionality.

STOP/TAIL/TURN

If equipped, activate the factory configured Stop/Tail/Turn by extending the following wires:

- 1) Orange wire to the taillight circuit
- 2) Green wire to the left brake/turn circuit
- 3) Blue/Black wire to the right brake/turn circuit

 If Stop/Tail/Turn functionality is specified at time of order, it will replace Mode 4, Cruise, & Dim functions.

MOUNTING STRAPS & BRACKETS

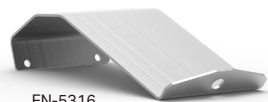

FN-5316

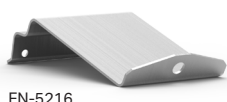

FN-5216

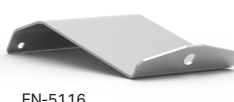

FN-5116

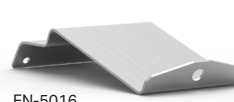

FN-5016

MAKE	MODEL	FROM	THROUGH	PART #
Chevrolet	Avalanche	2007	2013	FN-5016
Chevrolet	Caprice	2011	2017	FN-5316
Chevrolet	Colorado / Canyon	2015	2018	FN-5116
Chevrolet	2500 Heavy Duty	2014	2018	FN-5016
Chevrolet	Impala	2014	2018	FN-5316
Chevrolet	Malibu	2012	2016	FN-5316
Chevrolet/GMC	Silverado / Sierra	2014	2018	FN-5316
Chevrolet/GMC	Tahoe / Yukon / Suburban	2007	2014	FN-5016
Chevrolet/GMC	Tahoe / Yukon / Suburban	2015	2018	FN-5316
Chevrolet/GMC	Trailblazer / Envoy	2002	2009	FN-5016
Dodge	Charger	2011	2018	FN-5316
Dodge	Dakota	2005	2011	FN-5116
Dodge	Durango	2011	2018	FN-5116
Dodge	Ram 1500, 2500 & 3500	2012	2018	FN-5316
Ford	Crown Victoria	1998	2012	FN-5216
Ford	Escape	2013	2018	FN-5316
Ford	Excursion	2000	2006	FN-5316
Ford	Expedition	2007	2017	FN-5316
Ford	Explorer / Police Interceptor	2013	2018	FN-5316
Ford	F-150	2015	2018	FN-5316
Ford	F250, F350, F450	1999	2016	FN-5316
Ford	Fusion / Police Hybrid	2013	2019	FN-5316
Ford	Ranger	1998	2011	FN-5016
Ford	Taurus / Police Interceptor	2013	2018	FN-5316
Universal	Universal	N/A	N/A	FN-5316

UNIVERSAL BRACKETS

PART

Headache Rack Mount	FN-9816-M-H*
Permanent Mount	FN-9916-M-P*
Adjustable Foot Mount	FN-9927-AF*
Standard Foot Mount	FN-9716-M-F*

*Sold in pairs

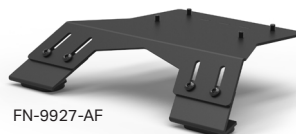

FN-9927-AF



FN-9716-M-F



FN-9816-M-H



FN-9916-M-P

HOOK KIT INSTRUCTIONS

INSTALLING A HOOK BRACKET

- 1) Remove the hex bolt from its packaging and slide the bolt through the hook bracket hole. See figure A.
- 2) Using a socket wrench and the hex bolt, loosely secure the hook bracket to the threaded hole in foot bracket. Repeat on the other side of the lightbar so both sides have the hook bracket secured. See figure B.
- 3) Place the lightbar with the attached hook brackets on the vehicle. Ensure the hook bracket is up right and seated correctly. See figure C.
- 4) Secure and tighten the bracket using a socket wrench on each side of the vehicle until the bar is snugly mounted. Use the included lock nut as a jam nut for extra security. Ensure the vehicle's door will close without any interference.

⚠ Do not overtighten the hex bolts. Do not exceed 165 in. lb. The use of blue thread locker is suggested.

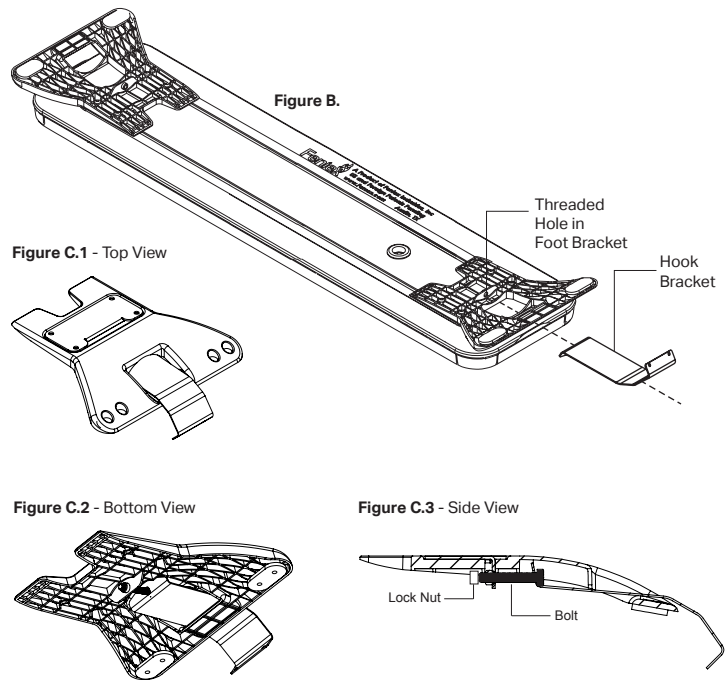
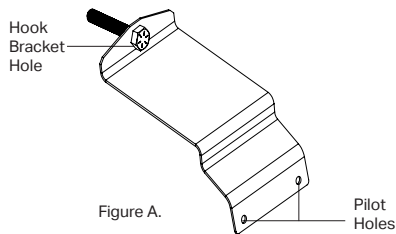

⚠ Use the "Hook Kit Compatibility Chart" for more information on page 8 of this manual.

- 5) Drill and secure the bracket to the vehicle with self-tapping screws, using the two pilot holes on the bottom of the hook bracket as a guide.
- 6) Once the bar is secure, drill a one inch hole to route the wire harness through the vehicle and then seal the hole with silicone. Ensure that wires are protected from rough edges using a rubber wire grommet.

⚠ Utilizing non-factory hardware and mounting brackets may result in loss of warranty coverage.